



**SOUTH FLORIDA WATER MANAGEMENT DISTRICT
ENVIRONMENTAL RESOURCE PERMIT NO. 36-00142-S**

DATE ISSUED: August 19, 2015

PERMITTEE: EAST COUNTY WATER CONTROL DISTRICT
601A EAST COUNTY LANE
LEHIGH ACRES, FL 33936

PROJECT DESCRIPTION: This Environmental Resource Permit Modification authorizes construction and operation of a storm water management system serving 161.50 acres of roadway widening known as SR 82 from Lee Blvd to Shawnee Road (Application No. 150225-8), and Shawnee Road to Alabama Road (Application No. 150324-2), within a project known as S.W. Recharge Project Modification totaling 1.09 acres.

PROJECT LOCATION: LEE COUNTY, SEC 33, 34, 35, 36 TWP 44S RGE 26E
SEC 1, 2, 3 4, 10, 11, 12 TWP 45S RGE 26E

PERMIT DURATION: See Special Condition No:1.

This is to notify you of the District's agency action for Permit Application No. 150623-2, dated June 23, 2015. This action is taken pursuant to the provisions of Chapter 373, Part IV, Florida Statutes (F.S).

Based on the information provided, District rules have been adhered to and an Environmental Resource Permit is in effect for this project subject to:

1. Not receiving a filed request for a Chapter 120, Florida Statutes, administrative hearing.
2. the attached 18 General Conditions (See Pages : 2 - 4 of 5),
3. the attached 6 Special Conditions (See Pages : 5 - 5 of 5) and
4. the attached 2 Exhibit(s)

Should you object to these conditions, please refer to the attached "Notice of Rights" which addresses the procedures to be followed if you desire a public hearing or other review of the proposed agency action. Please contact this office if you have any questions concerning this matter. If we do not hear from you in accordance with the "Notice of Rights," we will assume that you concur with the District's action.

CERTIFICATE OF SERVICE

I HEREBY CERTIFY THAT this written notice has been mailed or electronically transmitted to the Permittee (and the persons listed in the attached distribution list) this 19th day of August, 2015, in accordance with Section 120.60(3), F.S. Notice was also electronically posted on this date through a link on the home page of the District's website (my.sfwmd.gov/ePermitting).

BY: Melissa M. Roberts
Melissa M. Roberts, P.E.
Regulatory Administrator
Lower West Coast Service Center

NOTICE OF RIGHTS

As required by Sections 120.569 and 120.60(3), Fla. Stat., the following is notice of the opportunities which may be available for administrative hearing or judicial review when the substantial interests of a party are determined by an agency. Please note that this Notice of Rights is not intended to provide legal advice. Not all of the legal proceedings detailed below may be an applicable or appropriate remedy. You may wish to consult an attorney regarding your legal rights.

RIGHT TO REQUEST ADMINISTRATIVE HEARING

A person whose substantial interests are or may be affected by the South Florida Water Management District's (SFWMD or District) action has the right to request an administrative hearing on that action pursuant to Sections 120.569 and 120.57, Fla. Stat. Persons seeking a hearing on a SFWMD decision which affects or may affect their substantial interests shall file a petition for hearing with the Office of the District Clerk of the SFWMD, in accordance with the filing instructions set forth herein, within 21 days of receipt of written notice of the decision, unless one of the following shorter time periods apply: (1) within 14 days of the notice of consolidated intent to grant or deny concurrently reviewed applications for environmental resource permits and use of sovereign submerged lands pursuant to Section 373.427, Fla. Stat.; or (2) within 14 days of service of an Administrative Order pursuant to Section 373.119(1), Fla. Stat. "Receipt of written notice of agency decision" means receipt of written notice through mail, electronic mail, or posting that the SFWMD has or intends to take final agency action, or publication of notice that the SFWMD has or intends to take final agency action. Any person who receives written notice of a SFWMD decision and fails to file a written request for hearing within the timeframe described above waives the right to request a hearing on that decision.

If the District takes final agency action which materially differs from the noticed intended agency decision, persons who may be substantially affected shall, unless otherwise provided by law, have an additional Rule 28-106.111, Fla. Admin. Code, point of entry.

Any person to whom an emergency order is directed pursuant to Section 373.119(2), Fla. Stat., shall comply therewith immediately, but on petition to the board shall be afforded a hearing as soon as possible.

A person may file a request for an extension of time for filing a petition. The SFWMD may, for good cause, grant the request. Requests for extension of time must be filed with the SFWMD prior to the deadline for filing a petition for hearing. Such requests for extension shall contain a certificate that the moving party has consulted with all other parties concerning the extension and that the SFWMD and any other parties agree to or oppose the extension. A timely request for an extension of time shall toll the running of the time period for filing a petition until the request is acted upon.

FILING INSTRUCTIONS

A petition for administrative hearing must be filed with the Office of the District Clerk of the SFWMD. Filings with the Office of the District Clerk may be made by mail, hand-delivery, or e-mail. Filings by facsimile will not be accepted. A petition for administrative hearing or other document is deemed filed upon receipt during normal business hours by the Office of the District Clerk at SFWMD headquarters in West Palm Beach, Florida. The District's normal business hours are 8:00 a.m. – 5:00 p.m., excluding weekends and District holidays. Any document received by the Office of the District Clerk after 5:00 p.m. shall be deemed filed as of 8:00 a.m. on the next regular business day. Additional filing instructions are as follows:

- Filings by mail must be addressed to the Office of the District Clerk, P.O. Box 24680, West Palm Beach, Florida 33416.

- Filings by hand-delivery must be delivered to the Office of the District Clerk. Delivery of a petition to the SFWMD's security desk does not constitute filing. It will be necessary to request that the SFWMD's security officer contact the Office of the District Clerk. An employee of the SFWMD's Clerk's office will receive and file the petition.
- Filings by e-mail must be transmitted to the Office of the District Clerk at clerk@sfwmd.gov. The filing date for a document transmitted by electronic mail shall be the date the Office of the District Clerk receives the complete document. A party who files a document by e-mail shall (1) represent that the original physically signed document will be retained by that party for the duration of the proceeding and of any subsequent appeal or subsequent proceeding in that cause and that the party shall produce it upon the request of other parties; and (2) be responsible for any delay, disruption, or interruption of the electronic signals and accepts the full risk that the document may not be properly filed.

INITIATION OF AN ADMINISTRATIVE HEARING

Pursuant to Sections 120.54(5)(b)4. and 120.569(2)(c), Fla. Stat., and Rules 28-106.201 and 28-106.301, Fla. Admin. Code, initiation of an administrative hearing shall be made by written petition to the SFWMD in legible form and on 8 1/2 by 11 inch white paper. All petitions shall contain:

1. Identification of the action being contested, including the permit number, application number, SFWMD file number or any other SFWMD identification number, if known.
2. The name, address, any email address, any facsimile number, and telephone number of the petitioner and petitioner's representative, if any.
3. An explanation of how the petitioner's substantial interests will be affected by the agency determination.
4. A statement of when and how the petitioner received notice of the SFWMD's decision.
5. A statement of all disputed issues of material fact. If there are none, the petition must so indicate.
6. A concise statement of the ultimate facts alleged, including the specific facts the petitioner contends warrant reversal or modification of the SFWMD's proposed action.
7. A statement of the specific rules or statutes the petitioner contends require reversal or modification of the SFWMD's proposed action.
8. If disputed issues of material fact exist, the statement must also include an explanation of how the alleged facts relate to the specific rules or statutes.
9. A statement of the relief sought by the petitioner, stating precisely the action the petitioner wishes the SFWMD to take with respect to the SFWMD's proposed action.

MEDIATION

The procedures for pursuing mediation are set forth in Section 120.573, Fla. Stat., and Rules 28-106.111 and 28-106.401–405, Fla. Admin. Code. The SFWMD is not proposing mediation for this agency action under Section 120.573, Fla. Stat., at this time.

RIGHT TO SEEK JUDICIAL REVIEW

Pursuant to Section 120.68, Fla. Stat., and in accordance with Florida Rule of Appellate Procedure 9.110, a party who is adversely affected by final SFWMD action may seek judicial review of the SFWMD's final decision by filing a notice of appeal with the Office of the District Clerk of the SFWMD in accordance with the filing instructions set forth herein within 30 days of rendition of the order to be reviewed, and by filing a copy of the notice with the clerk of the appropriate district court of appeal.

GENERAL CONDITIONS

1. All activities shall be implemented following the plans, specifications and performance criteria approved by this permit. Any deviations must be authorized in a permit modification in accordance with Rule 62-330.315, F.A.C. Any deviations that are not so authorized shall subject the permittee to enforcement action and revocation of the permit under Chapter 373, F.S. (2012).
2. A complete copy of this permit shall be kept at the work site of the permitted activity during the construction phase, and shall be available for review at the work site upon request by the Agency staff. The permittee shall require the contractor to review the complete permit prior to beginning construction.
3. Activities shall be conducted in a manner that does not cause or contribute to violations of state water quality standards. Performance-based erosion and sediment control best management practices shall be installed immediately prior to, and be maintained during and after construction as needed, to prevent adverse impacts to the water resources and adjacent lands. Such practices shall be in accordance with the "State of Florida Erosion and Sediment Control Designer and Reviewer Manual" (Florida Department of Environmental Protection and Florida Department of Transportation June 2007), and the "Florida Stormwater Erosion and Sedimentation Control Inspector's Manual" (Florida Department of Environmental Protection, Nonpoint Source Management Section, Tallahassee, Florida, July 2008), unless a project-specific erosion and sediment control plan is approved or other water quality control measures are required as part of the permit.
4. At least 48 hours prior to beginning the authorized activities, the permittee shall submit to the Agency a fully executed Form 62-330.350(1), "Construction Commencement Notice" indicating the expected start and completion dates. If available, an Agency website that fulfills this notification requirement may be used in lieu of the form.
5. Unless the permit is transferred under Rule 62-330.340, F.A.C., or transferred to an operating entity under Rule 62-330.310, F.A.C., the permittee is liable to comply with the plans, terms and conditions of the permit for the life of the project or activity.
6. Within 30 days after completing construction of the entire project, or any independent portion of the project, the permittee shall provide the following to the Agency, as applicable:
 - a. For an individual, private single-family residential dwelling unit, duplex, triplex, or quadruplex- "Construction Completion and Inspection Certification for Activities Associated With a Private Single-Family Dwelling Unit"[Form 62-330.310(3)]; or
 - b. For all other activities- "As-Built Certification and Request for Conversion to Operational Phase" [Form 62-330.310(1)].
 - c. If available, an Agency website that fulfills this certification requirement may be used in lieu of the form.
7. If the final operation and maintenance entity is a third party:
 - a. Prior to sales of any lot or unit served by the activity and within one year of permit issuance, or within 30 days of as- built certification, whichever comes first, the permittee shall submit, as applicable, a copy of the operation and maintenance documents (see sections 12.3 thru 12.3.3 of Applicant's Handbook Volume I) as filed with the Department of State, Division of Corporations and a copy of any easement, plat, or deed restriction needed to operate or maintain the project, as recorded with the Clerk of the Court in the County in which the activity is located.
 - b. Within 30 days of submittal of the as- built certification, the permittee shall submit "Request for Transfer of Environmental Resource Permit to the Perpetual Operation Entity" [Form 62-330.310(2)] to transfer the permit to the operation and maintenance entity, along with the documentation requested in the form. If available, an Agency website that fulfills this transfer requirement may be used in lieu of the form.
8. The permittee shall notify the Agency in writing of changes required by any other regulatory agency that

GENERAL CONDITIONS

require changes to the permitted activity, and any required modification of this permit must be obtained prior to implementing the changes.

9. This permit does not:
 - a. Convey to the permittee any property rights or privileges, or any other rights or privileges other than those specified herein or in Chapter 62-330, F.A.C.;
 - b. Convey to the permittee or create in the permittee any interest in real property;
 - c. Relieve the permittee from the need to obtain and comply with any other required federal, state, and local authorization, law, rule, or ordinance; or
 - d. Authorize any entrance upon or work on property that is not owned, held in easement, or controlled by the permittee.
10. Prior to conducting any activities on state-owned submerged lands or other lands of the state, title to which is vested in the Board of Trustees of the Internal Improvement Trust Fund, the permittee must receive all necessary approvals and authorizations under Chapters 253 and 258, F.S. Written authorization that requires formal execution by the Board of Trustees of the Internal Improvement Trust Fund shall not be considered received until it has been fully executed.
11. The permittee shall hold and save the Agency harmless from any and all damages, claims, or liabilities that may arise by reason of the construction, alteration, operation, maintenance, removal, abandonment or use of any project authorized by the permit.
12. The permittee shall notify the Agency in writing:
 - a. Immediately if any previously submitted information is discovered to be inaccurate; and
 - b. Within 30 days of any conveyance or division of ownership or control of the property or the system, other than conveyance via a long-term lease, and the new owner shall request transfer of the permit in accordance with Rule 62-330.340, F.A.C. This does not apply to the sale of lots or units in residential or commercial subdivisions or condominiums where the stormwater management system has been completed and converted to the operation phase.
13. Upon reasonable notice to the permittee, Agency staff with proper identification shall have permission to enter, inspect, sample and test the project or activities to ensure conformity with the plans and specifications authorized in the permit.
14. If any prehistoric or historic artifacts, such as pottery or ceramics, stone tools or metal implements, dugout canoes, or any other physical remains that could be associated with Native American cultures, or early colonial or American settlement are encountered at any time within the project site area, work involving subsurface disturbance in the immediate vicinity of such discoveries shall cease. The permittee or other designee shall contact the Florida Department of State, Division of Historical Resources, Compliance and Review Section, at (850) 245-6333 or (800) 847-7278, as well as the appropriate permitting agency office. Such subsurface work shall not resume without verbal or written authorization from the Division of Historical Resources. If unmarked human remains are encountered, all work shall stop immediately and notification shall be provided in accordance with Section 872.05, F.S.
15. Any delineation of the extent of a wetland or other surface water submitted as part of the permit application, including plans or other supporting documentation, shall not be considered binding unless a specific condition of this permit or a formal determination under Rule 62-330.201, F.A.C., provides otherwise.
16. The permittee shall provide routine maintenance of all components of the stormwater management system to remove trapped sediments and debris. Removed materials shall be disposed of in a landfill or other

GENERAL CONDITIONS

uplands in a manner that does not require a permit under Chapter 62-330, F.A.C., or cause violations of state water quality standards.

17. This permit is issued based on the applicant's submitted information that reasonably demonstrates that adverse water resource-related impacts will not be caused by the completed permit activity. If any adverse impacts result, the Agency will require the permittee to eliminate the cause, obtain any necessary permit modification, and take any necessary corrective actions to resolve the adverse impacts.
18. A Recorded Notice of Environmental Resource Permit may be recorded in the county public records in accordance with Rule 62-330.090(7), F.A.C. Such notice is not an encumbrance upon the property.

SPECIAL CONDITIONS

1. The construction phase of this permit shall expire on August 19, 2020.
2. Operation and maintenance of the stormwater management system shall be the responsibility of the permittee.
3. Discharge Facilities: Through previously permitted facilities.
4. A stable, permanent and accessible elevation reference shall be established on or within one hundred (100) feet of all permitted discharge structures no later than the submission of the certification report. The location of the elevation reference must be noted on or with the certification report.
5. Prior to the commencement of construction activities on State Road 82 Application Nos 150225-8, and 150324-2, this application shall be constructed and certified.
6. The following are exhibits to this permit. Exhibits noted as incorporated by reference are available on the District's ePermitting website (<http://my.sfwmd.gov/ePermitting>) under this application number.

Exhibit No. 1.0 Location Map

Exhibit No. 2.0 Plans

Last Date For Agency Action: August 22, 2015

INDIVIDUAL ENVIRONMENTAL RESOURCE PERMIT STAFF REPORT

Project Name: S W Recharge Project Modification

Permit No.: 36-00142-S

Application No.: 150623-2 **Associated File:** 150225-8 ERP Concurrent

Application Type: Environmental Resource (Construction/Operation Modification)

Location: Lee County, S33, 34, 35, 36/T44S/R26E
S1, 2, 3 4, 10, 11, 12/T45S/R26E

Permittee : East County Water Control District

Operating Entity : Permittee

Project Area: 1.09 acres

Permit Area: 1.09 acres

Project Land Use: Roadway

Receiving Body: Tidal Caloosahatchee

Special Drainage District: NA

Conservation Easement To District : No

Sovereign Submerged Lands: No

PROJECT SUMMARY:

This Environmental Resource Permit Modification authorizes construction and operation of a storm water management system serving 161.50 acres of roadway widening known as SR 82 from Lee Blvd to Shawnee Road (Application No. 150225-8), and Shawnee Road to Alabama Road (Application No. 150324-2), within a project known as S.W. Recharge Project Modification totaling 1.09 acres. Plans are attached as Exhibit No. 2.0.

This is an application for the modification of the design and or location of previously permitted (Application No. 100325-12) structures 5, 9, 10, 11, and 14 within the E.C.W.C.D. storm water management system, as follows:

Structure 5 will be constructed approximately 300 feet to the west of the previously permitted location and converted from a weir to a drop structure with culverts. The hydraulic dimensions of the structure remain the same. Two under flow gates will be added to lower stages prior to major storm events.

Structure 9 is being constructed approximately 600 feet to the east of the previously permitted location. This moves it away from the existing culvert crossing of Gunnery Road. It is a gate only operated structure and serves as a basin divide during the dry season.

Structure 10 remains in the same location as previously permitted, however the culverts are being changed from 2 - 36 inch RCP to 2 - 48 inch RCP. No other changes to the proposed structure are requested.

Structures 11 & 14 will not be constructed as they are no longer required.

Issuance of this permit constitutes certification of compliance with state water quality standards in accordance with Rule 62-330.062 Florida Administrative Code (F.A.C.).

PROJECT EVALUATION:**PROJECT SITE DESCRIPTION:**

The proposed project involves modification to three existing Structures, Nos. 5, 9, and 10 and the removal of Structure Nos. 11 & 14. The structures are part of the East County Water Control District (E.C.W.C.D.) in Lehigh Acres, Lee County, Florida. The location of these structures is shown on Exhibit No. 1.0, page 2 of 2.

The project area consists of existing canals and right-of ways. There are no wetlands within or affected by the proposed project. No adverse environmental conditions are anticipated as a result of the weir structure replacements.

BACKGROUND:

Since the 1990's East County Water Control District (ECWCD) has been operating and maintaining the control structures within their canal system, including variations of wet and dry season control elevations on structure replacements, to increase surface water storage and promote groundwater recharge without causing adverse impacts in storm events. The Southwest Recharge Project was last permitted on July 20, 2010, under Application No. 100325-12.

The current application proposes modification to the location and or design of five of the previously permitted structures.

LAND USE:**Construction****Project:**

| | This Phase | Total Project | |
|---------------|-------------|---------------|-------|
| Pavement | .10 | .10 | acres |
| Pervious | .99 | .99 | acres |
| Total: | 1.09 | 1.09 | |

WATER QUANTITY :**Discharge Rate :**

The project is consistent with the design of the East County Water Control District (E.C.W.C.D.) Master Storm Water Management System. The proposed weirs included in this modification are internal to the E.C.W.C.D. system, and therefore, the flow has not been limited for the design event to a specified rate.

WATER QUALITY :

This project is providing the required Water Quality treatment for Application Nos. 150225-8, and 150324- 2 pursuant to the Joint Use Management System Agreement (J.U.S.M.S.A.). Please see Exhibit No. 2.5 in Application No. 150228-8.

In addition to the water quality treatment volume, the applicant provided site specific pollutant loading calculations to demonstrate that the storm water management system reduces the post development loading of pollutants from the Right-Of-Way to levels less than the loadings generated under the pre-

development condition. The pollutant loading calculations are based upon the removal characteristics associated with the system. Please see Exhibit No. 2.6, Application Nos. 150225-8 and 150324-2.

CERTIFICATION, OPERATION, AND MAINTENANCE:

Pursuant to Chapter 62-330.310 Florida Administrative Code (F.A.C.), Individual Permits will not be converted from the construction phase to the operation phase until construction completion certification of the project is submitted to and accepted by the District. This includes compliance with all permit conditions, except for any long term maintenance and monitoring requirements. It is suggested that the permittee retain the services of an appropriate professional registered in the State of Florida for periodic observation of construction of the project.

For projects permitted with an operating entity that is different from the permittee, it should be noted that until the construction completion certification is accepted by the District and the permit is transferred to an acceptable operating entity pursuant to Sections 12.1-12.3 of the Applicant's Handbook Volume I and Section 62-330.310, F.A.C., the permittee is liable for operation and maintenance in compliance with the terms and conditions of this permit.

In accordance with Section 373.416(2), F.S., unless revoked or abandoned, all stormwater management systems and works permitted under Part IV of Chapter 373, F.S., must be operated and maintained in perpetuity.

The efficiency of stormwater management systems, dams, impoundments, and most other project components will decrease over time without periodic maintenance. The operation and maintenance entity must perform periodic inspections to identify if there are any deficiencies in structural integrity, degradation due to insufficient maintenance, or improper operation of projects that may endanger public health, safety, or welfare, or the water resources. If deficiencies are found, the operation and maintenance entity will be responsible for correcting the deficiencies in a timely manner to prevent compromises to flood protection and water quality. See Section 12.4 of Applicant's Handbook Volume I for Minimum Operation and Maintenance Standards.

RELATED CONCERNS:

Water Use Permit Status:

The applicant has indicated that irrigation water and dewatering are not required for construction of this project.

This permit does not release the permittee from obtaining all necessary Water Use authorization(s) prior to the commencement of activities which will require such authorization, including construction dewatering and irrigation.

CERP:

The proposed project is not located within or adjacent to a Comprehensive Everglades Restoration Project component.

Right-Of-Way Permit Status:

A District Right-of-Way Permit is not required for this project.

Historical/Archeological Resources:

The District has received correspondence from the Florida Department of State, Division of Historical Resources indicating that no significant archaeological or historical resources are recorded in the project area and the project is therefore unlikely to have an effect upon any such properties. This permit does not release the permittee from compliance with any other agencies' requirements in the event that historical and/or archaeological resources are found on the site.

DEO/CZM Consistency Review:

The issuance of this permit constitutes a finding of consistency with the Florida Coastal Management Program.

Third Party Interest:

No third party has contacted the District with concerns about this application.

Enforcement:

There has been no enforcement activity associated with this application.

STAFF REVIEW:

DIVISION APPROVAL:

NATURAL RESOURCE MANAGEMENT:

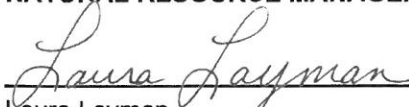

Laura Layman

DATE: 8/19/15



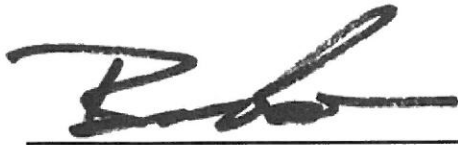

SURFACE WATER MANAGEMENT:



Brian Rose, P.E.

DATE: 8/19/15

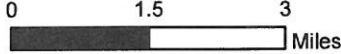

| | | | |
|---|---|----------------|---|
| Exhibit No: 1 | Exhibit Created On: 2015-06-24 | LEE COUNTY, FL | |
| REGULATION DIVISION Project Name: SW RECHARGE PROJECT MODIFICATION | | |  Application Permit No: 36-00142-S Application Number: 150623-2 |
|    |  sfwmd.gov Created by Regulation GIS Section South Florida Water Management District | | |

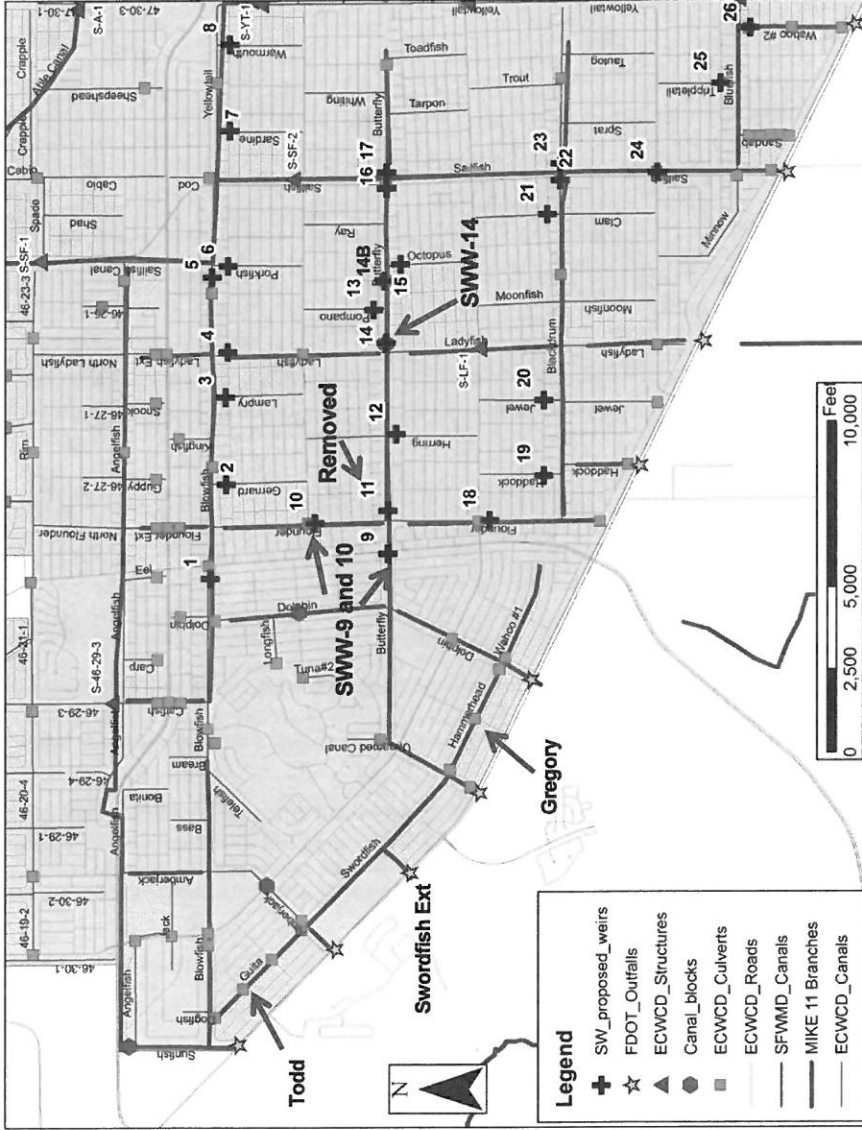
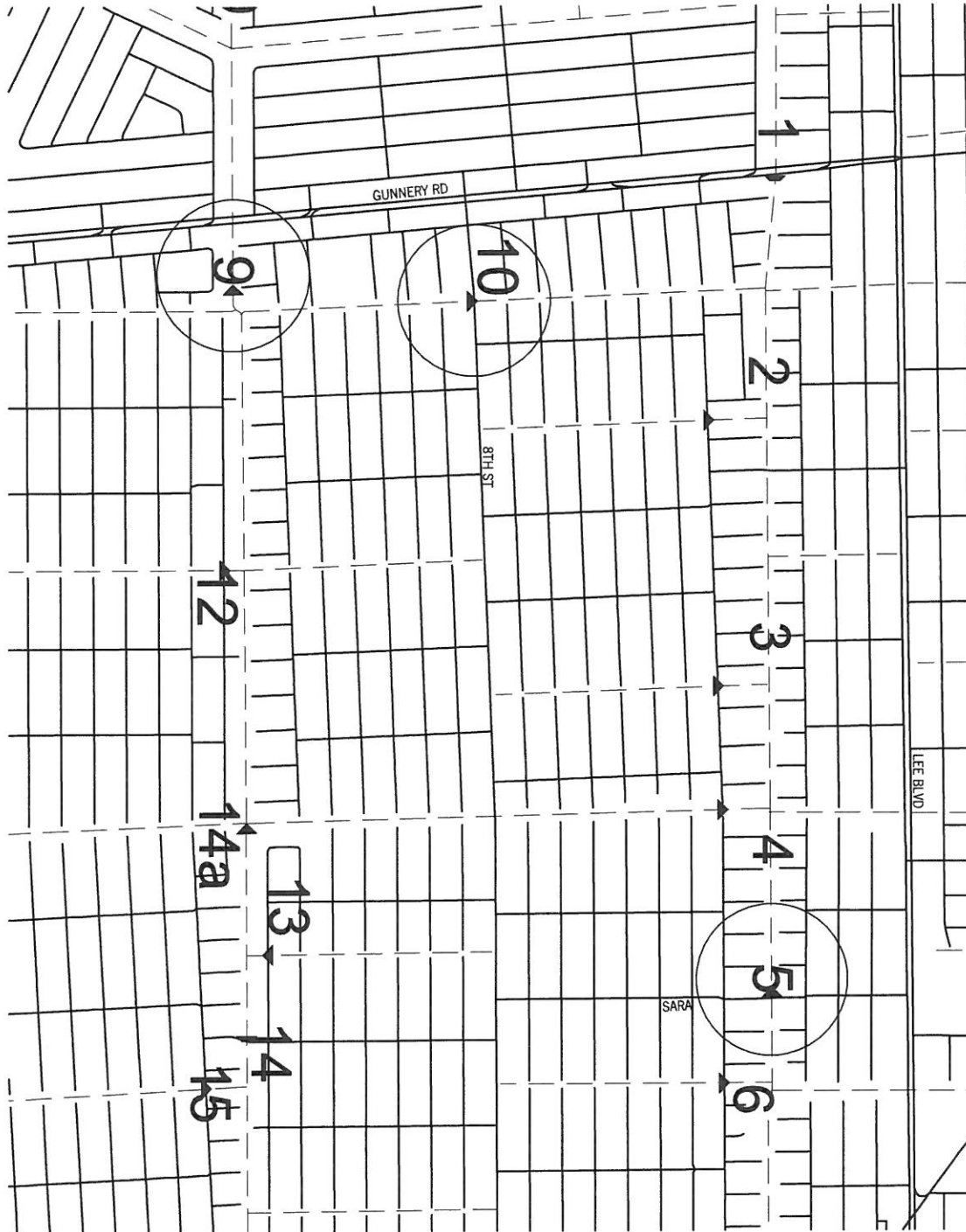

Figure 1 – Map of Project Area



1" = 1000'



DATE:
 Richard H. Thompson, P.E. # 46720
R.H.T. Engineering, Inc.
 319 Inman Street
 Lehigh Acres, FL 33936
 (239) 369-8900
 Engineering Certificate of Authorization
 # 25852

| | |
|---|---------------------|
| SOUTHWEST RECHARGE PROJECT | |
| Client: EAST COUNTY WATER CONTROL DISTRICT | STRUCTURE LOCATIONS |
| LEE COUNTY | SHEET 1/4 |

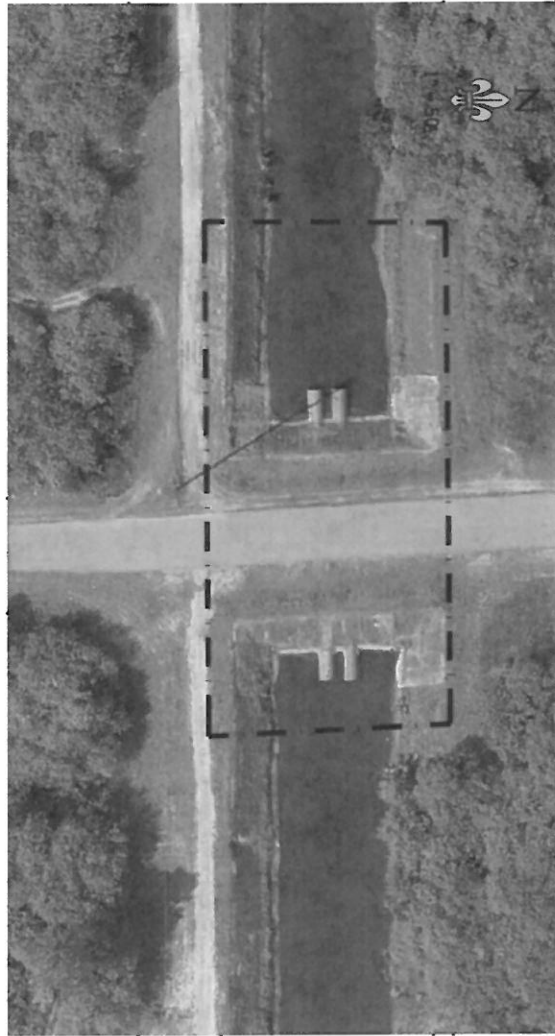

- NOTES**
1. CONSTRUCTION AREA IS 0.5 ACRES.
 2. TURBIDITY CURTAIN SHALL BE INSTALLED DOWN STREAM OF PROJECT PRIOR TO CONSTRUCTION.
 3. SILT FENCE SHALL BE INSTALLED AT PERIMETER OF PROJECT AREA PRIOR TO CONSTRUCTION
 4. REVERTMENT MAT SHALL BE REPAIRED AFTER CULVERT REPLACEMENT
 5. EXISTING 90" CMP SHALL BE REPLACED WITH 72" RCP.

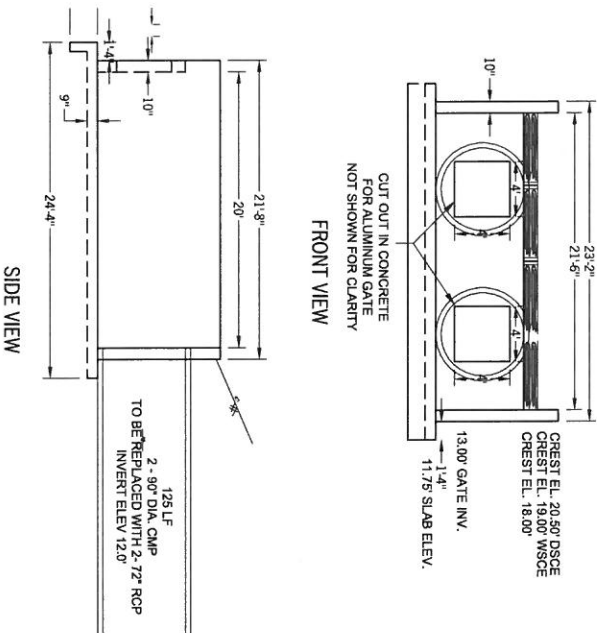
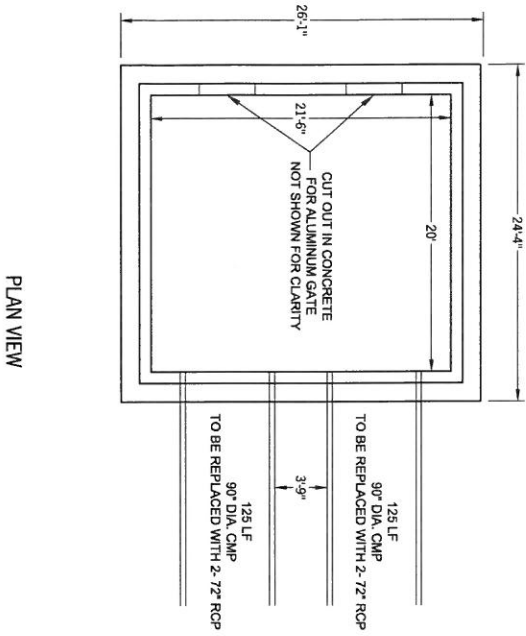

DATE:
 Richard H. Thompson, P.E. # 46720
R.H.T. Engineering, Inc.
 319 Inman Street
 Lehigh Acres, FL 33936
 (239) 369-8900
 Engineering Certificate of Authorization
 # 25852

SOUTHWEST RECHARGE PROJECT

Client:
 EAST COUNTY WATER CONTROL DISTRICT

STRUCTURE 5

LEE COUNTY

SHEET 2/4

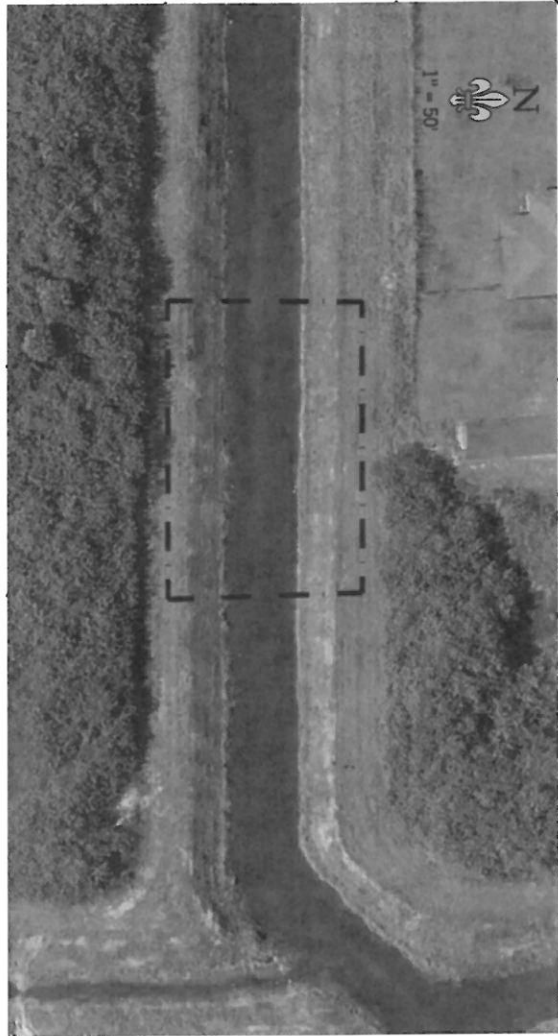

- NOTES
1. CONSTRUCTION AREA IS 0.25 ACRES.
 2. TURBIDITY CURTAIN SHALL BE INSTALLED DOWN STREAM OF PROJECT PRIOR TO CONSTRUCTION.
 3. SILT FENCE SHALL BE INSTALLED AT PERIMETER OF PROJECT AREA PRIOR TO CONSTRUCTION

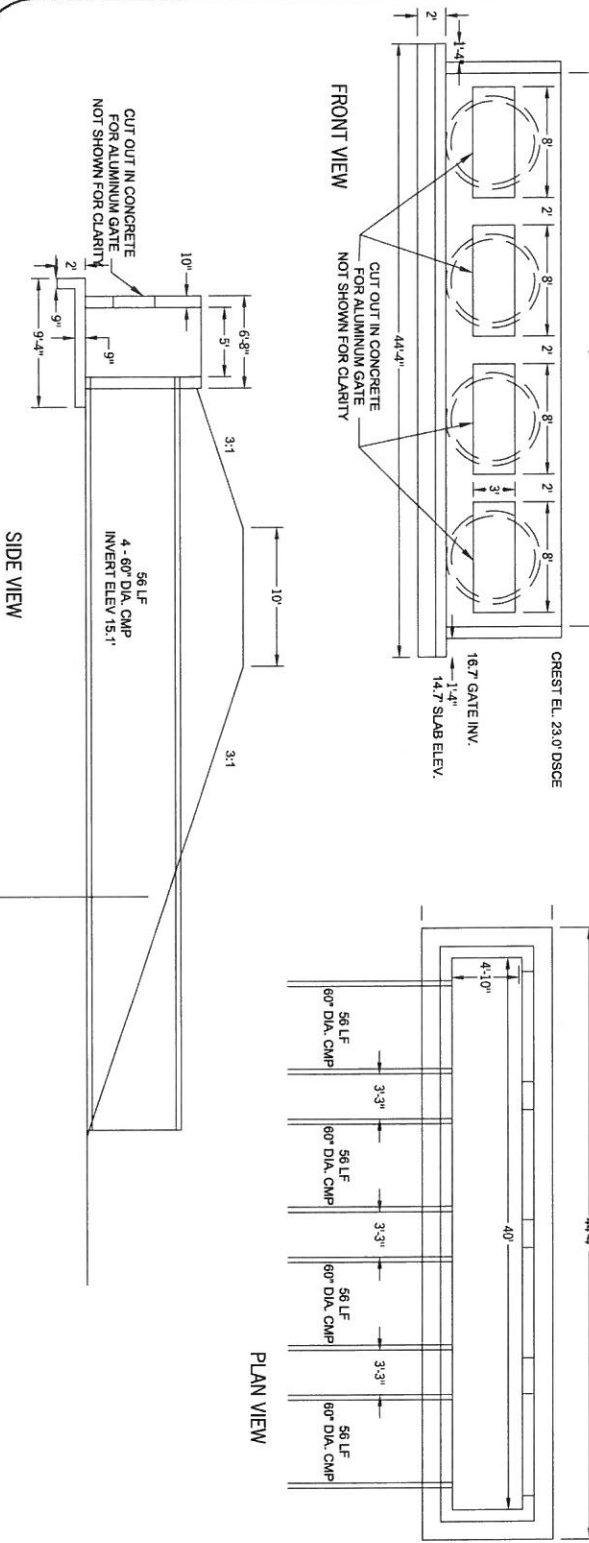

DATE:
 Richard H. Thompson, P.E. # 46720
R.H.T. Engineering, Inc.
 319 Inman Street
 Lehigh Acres, FL 33936
 (239) 369-8900
 Engineering Certificate of Authorization
 # 25852

| | |
|---|-------------|
| SOUTHWEST RECHARGE PROJECT | |
| Client: EAST COUNTY WATER CONTROL DISTRICT | STRUCTURE 9 |
| LEE COUNTY | SHEET 3/4 |

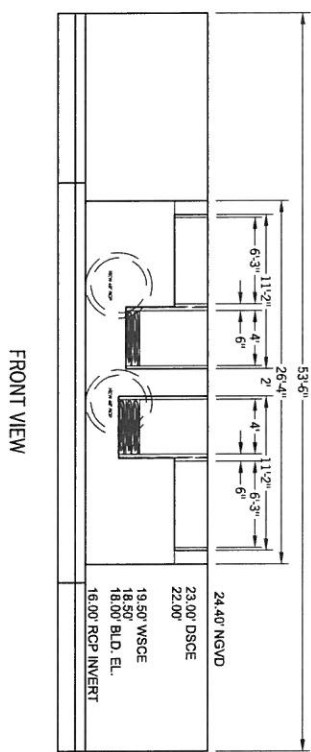
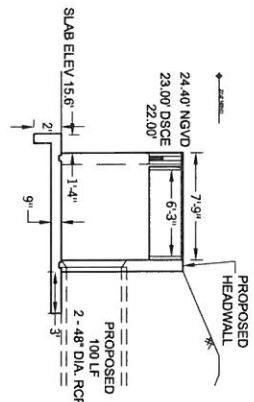
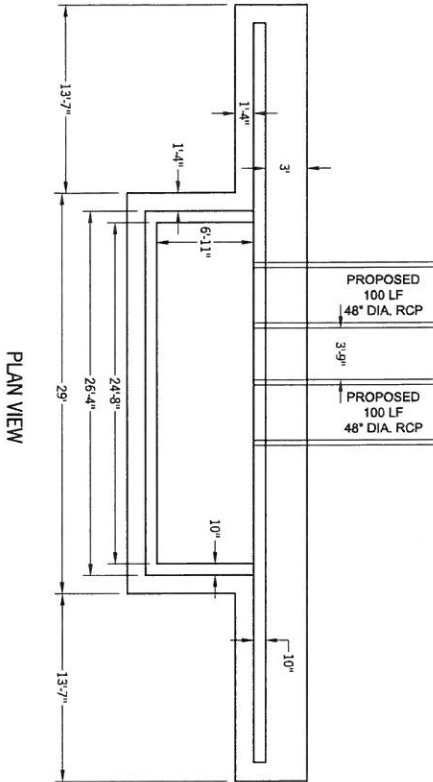

- NOTES
1. CONSTRUCTION AREA IS 0.3 ACRES.
 2. TURBIDITY CURTAIN SHALL BE INSTALLED DOWN STREAM OF PROJECT PRIOR TO CONSTRUCTION.
 3. SILT FENCE SHALL BE INSTALLED AT PERIMETER OF PROJECT AREA PRIOR TO CONSTRUCTION.
 4. EXISTING 36" RCP SHALL BE REPLACED WITH 48" RCP



DATE:
 Richard H. Thompson, P.E. # 46720
R.H.T. Engineering, Inc.
 319 Inman Street
 Lehigh Acres, FL 33936
 (239) 369-8900
 Engineering Certificate of Authorization
 # 25852

| | |
|---|--------------|
| SOUTHWEST RECHARGE PROJECT | |
| Client: EAST COUNTY WATER CONTROL DISTRICT | STRUCTURE 10 |
| LEE COUNTY | SHEET 4/4 |

STAFF REPORT DISTRIBUTION LIST

S W RECHARGE PROJECT MODIFICATION

Application No: 150623-2

Permit No: 36-00142-S

INTERNAL DISTRIBUTION

- X Errol Noel
- X Jewelene S. Harris
- X Laura Layman
- X Melissa M. Roberts, P.E.
- X A. Waterhouse

EXTERNAL DISTRIBUTION

- X Permittee- East County Water Control District
- X Agent - R H T Engineering

GOVERNMENT AGENCIES

- X Div of Recreation and Park - District 4 - Chris Becker,
FDEP

OTHER INTERESTED PARTIES

- X Audubon of Florida - Charles Lee

STAFF REPORT DISTRIBUTION LIST

ADDRESSES

R H T Engineering
319 Inman Street
Lehigh Acres FL 33936
richard@rhtengineering.com

East Count Water Control District
601a East County Lane
Lehigh Acres FL 33936
mcook@ecwcd.com

Div of Recreation and Park - District 4 - Chris Becker,
FDEP
1843 South Tamiami Trail
Osprey FL 34229
chris.becker@dep.state.fl.us

Audubon of Florida - Charles Lee
1101 Audubon Way
Maitland FL 32751
chlee2@earthlink.net